

## SC160N120Y

### 18 Amps, 1200 Volts N-Channel Sic Power MOSFET

#### Features

- 18A, 1200V,  $R_{DS(ON)MAX}=196m\Omega @V_{GS}=20V/10A$
- High Blocking Voltage with low On-Resistance
- High Speed Switching with Low Capacitance
- Easy to Parallel and Simple to Drive

#### Benefits

- Higher System Efficiency
- Reduced Cooling Requirements
- Increased Power Density
- Increased System Switching Frequencytance

#### Applications

- Solar Inverters
- High Voltage DC/DC Converters
- Motor Drivers
- Switch Mode Power Supplies
- Pulsed Power applications

TO-247-3L

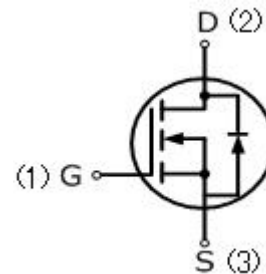
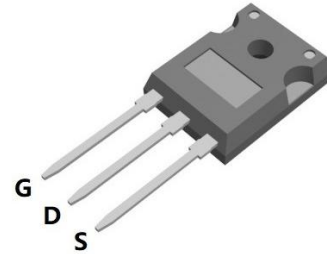

#### Absolute Maximum Ratings ( $T_c=25^\circ\text{C}$ , unless otherwise noted)

Parameter	Symbol	Value	UNIT	Test Conditions
Drain-Source Voltage	$V_{DSmax}$	1200	V	$V_{GS}=0V, I_{DS}=100\mu A$
Gate-Source Voltage(dynamic)	$V_{GSmax}$	-10/+25		Absolute maximum values
Gate-Source Voltage (static)	$V_{GSop}$	-5/+20		Recommended operational values
Continuous Drain Current	$I_D$	18	A	$V_{GS}=20V, T_c=25^\circ\text{C}$
Pulsed Drain Current	$I_{D(pulse)}$	40	A	Pulse width $t_p$ limited by $T_{Jmax}$
Power Dissipation	$P_D$	100	W	$T_c=25^\circ\text{C}, T_J=150^\circ\text{C}$
Operating Junction and Storage Temperature Range	$T_J, T_{STG}$	-55 to +150	$^\circ\text{C}$	

#### Thermal Characteristics

Parameter	Symbol	SC160N120Y	Units
Maximum Junction-to-Case	$R_{thJC}$	1.25	$^\circ\text{C}/\text{W}$

<b>Electrical Characteristics</b> ( $T_c=25^\circ\text{C}$ , unless otherwise noted)						
Parameter	Symbol	Test Conditions	Min	Typ	Max	Units
<b>Off Characteristics</b>						
Drain-Source Breakdown Voltage	$BV_{DSS}$	$V_{GS}=0V, I_D=100\mu A, T_C=25^\circ\text{C}$	1200	—	—	V
Zero Gate Voltage Drain Current	$I_{DSS}$	$V_{DS}=1200V, V_{GS}=0V$	—	1	100	$\mu A$
Gate-Body Leakage Current, Forward	$I_{GSSF}$	$V_{GS}=25V, V_{DS}=0V$	—	10	250	nA
Gate-Body Leakage Current, Reverse	$I_{GSSR}$	$V_{GS}=-10V, V_{DS}=0V$	—	10	250	nA
<b>On Characteristics</b>						
Gate-Source Threshold Voltage	$V_{GS(th)}$	$V_{DS}=V_{GS}, I_D=2.5mA$	2.0	2.4	4.0	V
Drain-Source On-State Resistance	$R_{DS(on)}$	$V_{GS}=20V, I_D=10A$	—	160	196	m $\Omega$
		$V_{GS}=20V, I_D=10A, T_J=150^\circ\text{C}$	—	280	—	
<b>Dynamic Characteristics</b>						
Input Capacitance	$C_{iss}$	$V_{DS}=1000V,$	—	890	—	pF
Output Capacitance	$C_{oss}$	$V_{GS}=0V,$	—	54	—	pF
Reverse Transfer Capacitance	$C_{rss}$	$f=1.0MHz,$	—	8.5	—	pF
Coss Stored Energy	$E_{oss}$	$V_{AC}=25mV$	—	31	—	$\mu J$
<b>Switching Characteristics</b>						
Turn-On Delay Time	$t_{d(on)}$	$V_{DS}=800V, V_{GS}=-5V/20V,$ $I_D=10A, R_g=2.5\Omega, R_L=80\Omega$	—	8	—	ns
Turn-On Rise Time	$t_r$		—	9	—	ns
Turn-Off Delay Time	$t_{d(off)}$		—	14	—	ns
Turn-Off Fall Time	$t_f$		—	9	—	ns
Turn-On Switching Energy	$E_{ON}$	$V_{DS}=800V, V_{GS}=-5V/20V$	—	315	—	$\mu J$
Turn-Off Switching Energy	$E_{OFF}$	$I_D=10A, R_g=2.5\Omega, L=200\mu H$	—	63	—	$\mu J$
Internal Gate Resistance	$R_G$	$f=1MHz, V_{AC}=25mV$	—	5.5	—	$\Omega$
Total Gate Charge	$Q_g$	$V_{DS}=800V, I_D=10A,$ $V_{GS}=-5V/20V$	—	49	—	nC
Gate-Source Charge	$Q_{GS}$		—	17	—	
Gate-Drain Charge	$Q_{gd}$		—	9	—	
<b>Reverse Diode Characteristics</b>						
Diode Forward Voltage	$V_{SD}$	$V_{GS}=-5V, I_{SD}=5A$	—	4.2	—	V
Continuous Diode Forward Current	$I_S$	$T_C=25^\circ\text{C}$	—	—	23	A
Reverse Recover Time	$t_{rr}$	$V_R=800V, I_{SD}=10A$	—	28	—	ns
Reverse Recovery Charge	$Q_{rr}$		—	50	—	nc
Peak Reverse Recovery Current	$I_{rrm}$		—	3	—	A

## RATING AND CHARACTERISTIC CURVES

Figure.1 Output Characteristics  $T_j=25^\circ\text{C}$

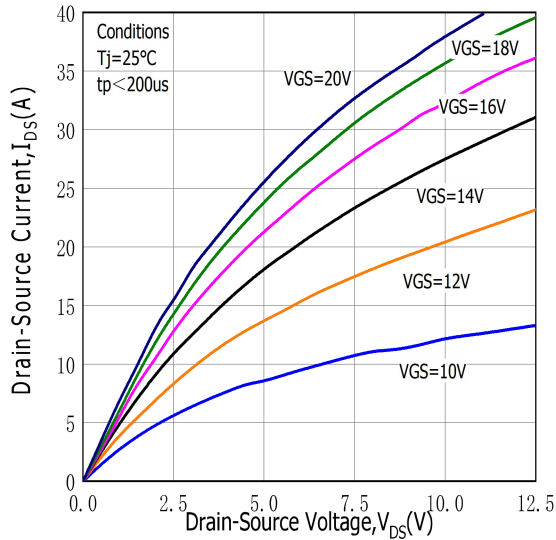

Figure.2 Output Characteristics  $T_j=150^\circ\text{C}$

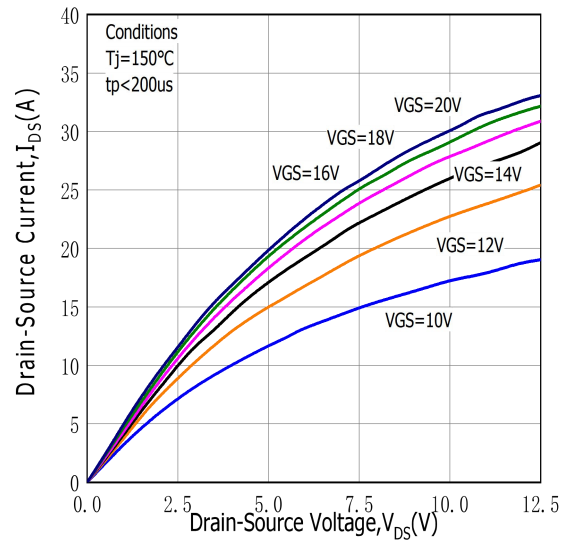

Figure.3 On-Resistance vs. Temperature

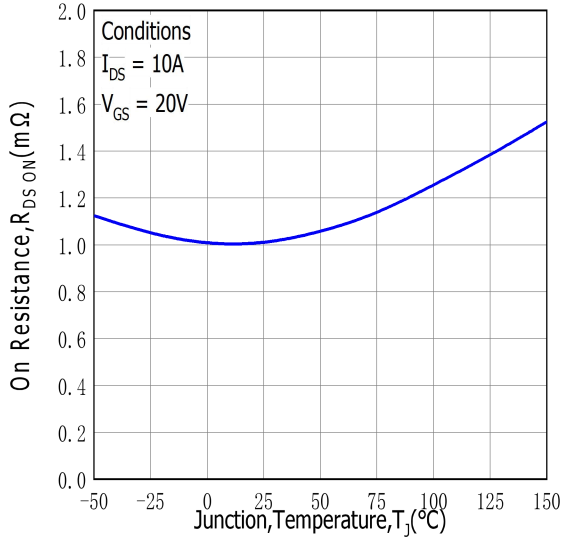

Figure.4 On-Resistance vs. Drain Current for Various Temperatures

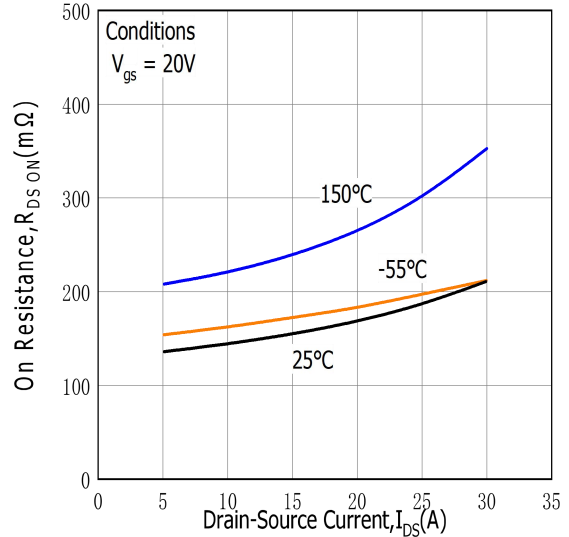

Figure.5 On-Resistance vs. Temperature for Various Gate Voltage

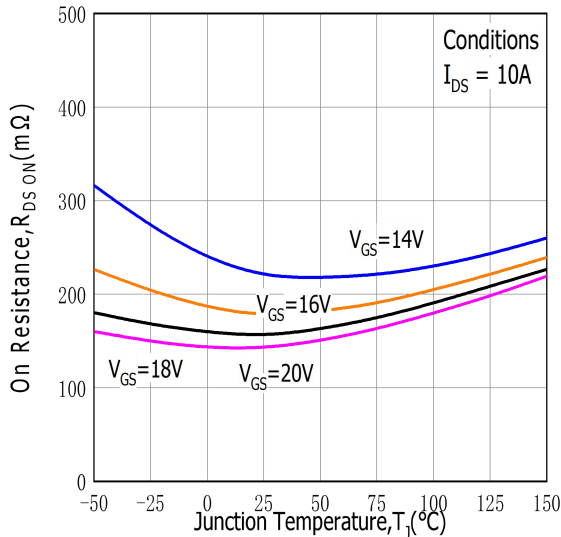

Figure.6 Transfer Characteristic for Various Junction Temperatures

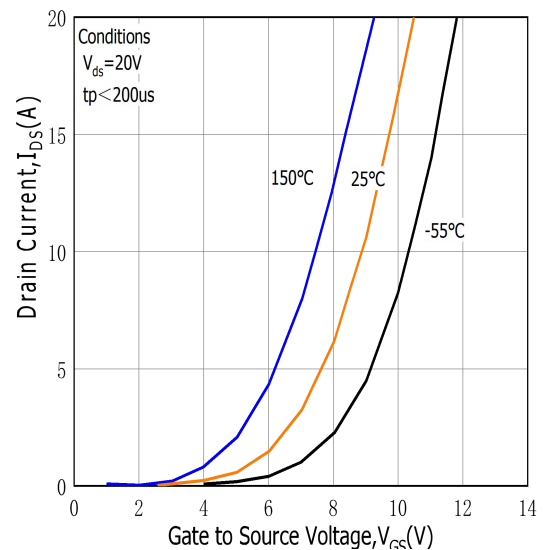

Figure.7 Body Diode Characteristic at 25°C

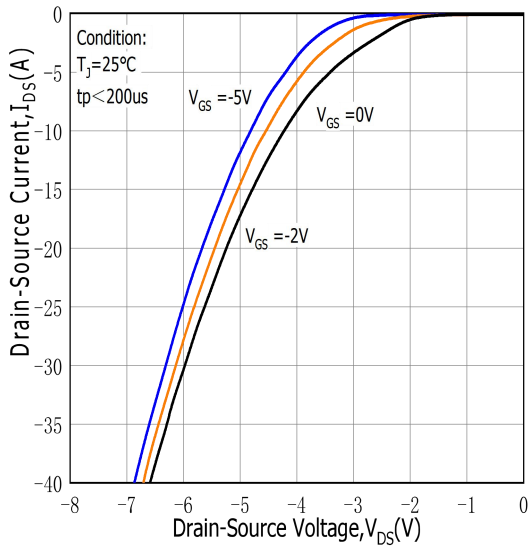

Figure.8 Body Diode Characteristic at 150°C

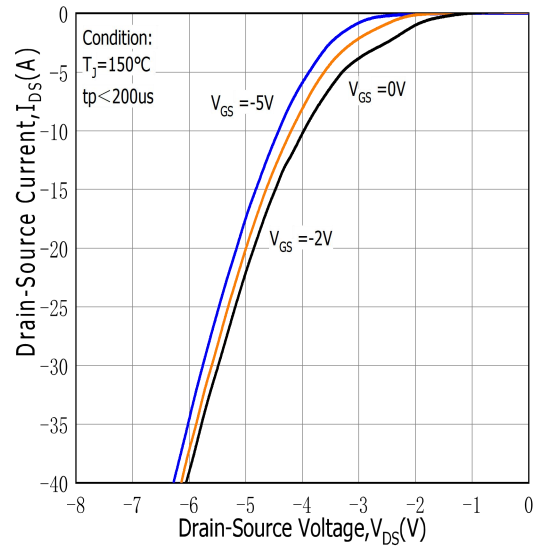

Figure.9 Threshold Voltage vs. Temperature

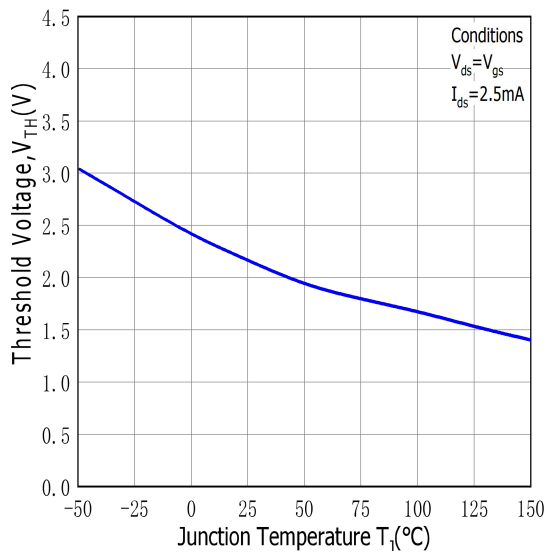

Figure.10 Capacitances vs. Drain-Source Voltage(0-200V)

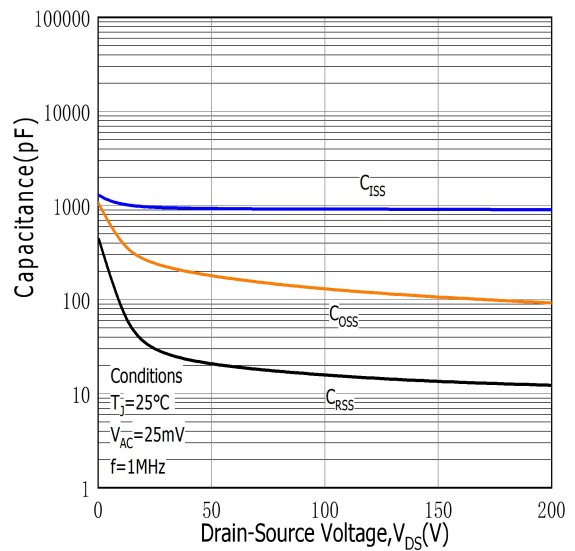
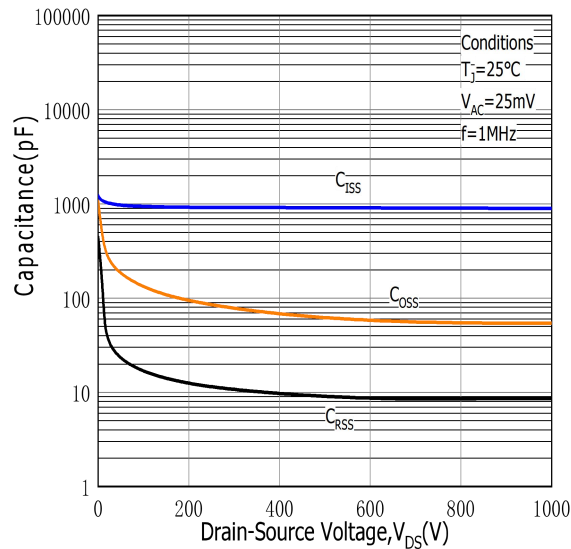
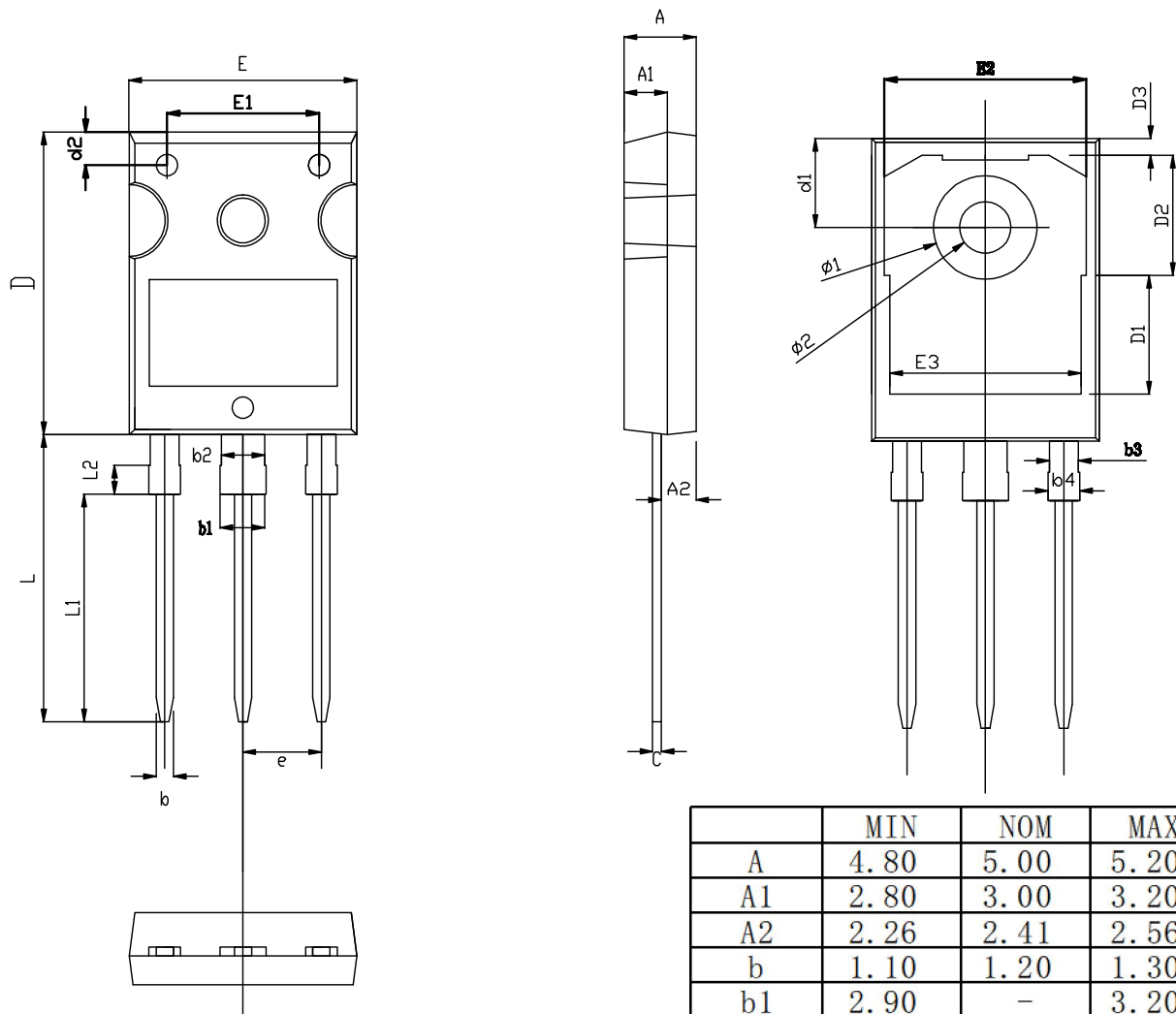

Figure.11 Capacitances vs. Drain-Source Voltage(0-1000V)



# TO-247-3L PACKAGE OUTLINE



RECOMMENDED LAND PATTERN

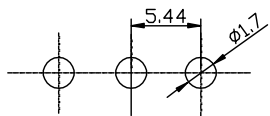

UNIT: mm

	MIN	NOM	MAX
A	4.80	5.00	5.20
A1	2.80	3.00	3.20
A2	2.26	2.41	2.56
b	1.10	1.20	1.30
b1	2.90	-	3.20
b2	2.90	3.00	3.10
b3	1.90	2.00	2.10
b4	2.00	-	2.20
c	0.50	0.60	0.70
D	20.80	21.00	21.20
D1		8.23	
D2		8.32	
D3		1.17	
d1	6.00	6.15	6.30
d2	2.20	2.30	2.40
E	15.60	15.80	16.00
E1		10.50	
E2		14.02	
E3		13.50	
e	5.34	5.44	5.54
L	19.72	19.92	20.12
L1		15.79	
L2		1.98	
ø1	7.10	7.19	7.30
ø2	3.50	3.60	3.70