

SC160N120Y4

18 Amps, 1200 Volts N-Channel Sic Power MOSFET

Features

- 18A, 1200V, $R_{DS(ON)MAX}=196m\Omega @V_{GS}=20V/10A$
- High Blocking Voltage with low On-Resistance
- High Speed Switching with Low Capacitance
- Easy to Parallel and Simple to Drive

Benefits

- Higher System Efficiency
- Reduced Cooling Requirements
- Increased Power Density
- Increased System Switching Frequencytance

Applications

- Solar Inverters
- High Voltage DC/DC Converters
- Motor Drivers
- Switch Mode Power Supplies
- Pulsed Power applications

TO-247-4L

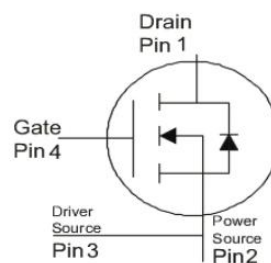
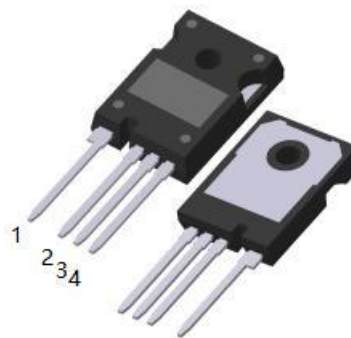

Absolute Maximum Ratings ($T_c=25^\circ\text{C}$, unless otherwise noted)

Parameter	Symbol	Value	UNIT	Test Conditions
Drain-Source Voltage	V_{DSmax}	1200	V	$V_{GS}=0V, I_{DS}=100\mu A$
Gate-Source Voltage(dynamic)	V_{GSmax}	-10/+25		Absolute maximum values
Gate-Source Voltage (static)	V_{GSop}	-5/+20		Recommended operational values
Continuous Drain Current	I_D	18	A	$V_{GS}=20V, T_c=25^\circ\text{C}$
Pulsed Drain Current	$I_{D(pulse)}$	40	A	Pulse width t_p limited by T_{Jmax}
Power Dissipation	P_D	100	W	$T_c=25^\circ\text{C}, T_J=150^\circ\text{C}$
Operating Junction and Storage Temperature Range	T_J, T_{STG}	-55 to +150	$^\circ\text{C}$	

Thermal Characteristics

Parameter	Symbol	SC160N120Y4	Units
Maximum Junction-to-Case	R_{thJC}	1.25	$^\circ\text{C}/\text{W}$

Electrical Characteristics ($T_c=25^\circ\text{C}$, unless otherwise noted)						
Parameter	Symbol	Test Conditions	Min	Typ	Max	Units
Off Characteristics						
Drain-Source Breakdown Voltage	BV_{DSS}	$V_{GS}=0V, I_D=100\mu A, T_C=25^\circ\text{C}$	1200	—	—	V
Zero Gate Voltage Drain Current	I_{DSS}	$V_{DS}=1200V, V_{GS}=0V$	—	1	100	μA
Gate-Body Leakage Current, Forward	I_{GSSF}	$V_{GS}=25V, V_{DS}=0V$	—	10	250	nA
Gate-Body Leakage Current, Reverse	I_{GSSR}	$V_{GS}=-10V, V_{DS}=0V$	—	10	250	nA
On Characteristics						
Gate-Source Threshold Voltage	$V_{GS(th)}$	$V_{DS}=V_{GS}, I_D=2.5\text{mA}$	2.0	2.4	4.0	V
Drain-Source On-State Resistance	$R_{DS(on)}$	$V_{GS}=20V, I_D=10A$	—	160	196	m Ω
		$V_{GS}=20V, I_D=10A, T_J=150^\circ\text{C}$	—	280	—	
Dynamic Characteristics						
Input Capacitance	C_{iss}	$V_{DS}=1000V,$	—	890	—	pF
Output Capacitance	C_{oss}	$V_{GS}=0V,$	—	54	—	pF
Reverse Transfer Capacitance	C_{rss}	$f=1.0\text{MHZ},$	—	8.5	—	pF
Coss Stored Energy	E_{oss}	$V_{AC}=25\text{mV}$	—	31	—	μJ
Switching Characteristics						
Turn-On Delay Time	$t_{d(on)}$	$V_{DS}=800V, V_{GS}=-5V/20V,$ $I_D=10A, R_g=2.5\Omega, R_L=80\Omega$	—	8	—	ns
Turn-On Rise Time	t_r		—	9	—	ns
Turn-Off Delay Time	$t_{d(off)}$		—	14	—	ns
Turn-Off Fall Time	t_f		—	9	—	ns
Turn-On Switching Energy	E_{ON}	$V_{DS}=800V, V_{GS}=-5V/20V$	—	315	—	μJ
Turn-Off Switching Energy	E_{OFF}	$I_D=10A, R_g=2.5\Omega, L=200\mu\text{H}$	—	63	—	μJ
Internal Gate Resistance	R_G	$f=1\text{MHz}, V_{AC}=25\text{mV}$	—	5.5	—	Ω
Total Gate Charge	Q_g	$V_{DS}=800V, I_D=10A,$ $V_{GS}=-5V/20V$	—	49	—	nC
Gate-Source Charge	Q_{GS}		—	17	—	
Gate-Drain Charge	Q_{gd}		—	9	—	
Reverse Diode Characteristics						
Diode Forward Voltage	V_{SD}	$V_{GS}=-5V, I_{SD}=5A$	—	4.2	—	V
Continuous Diode Forward Current	I_S	$T_C=25^\circ\text{C}$	—	—	23	A
Reverse Recover Time	t_{rr}	$V_R=800V, I_{SD}=10A$	—	28	—	ns
Reverse Recovery Charge	Q_{rr}		—	50	—	nc
Peak Reverse Recovery Current	I_{rrm}		—	3	—	A

RATING AND CHARACTERISTIC CURVES

Figure.1 Output Characteristics $T_j=25^\circ\text{C}$

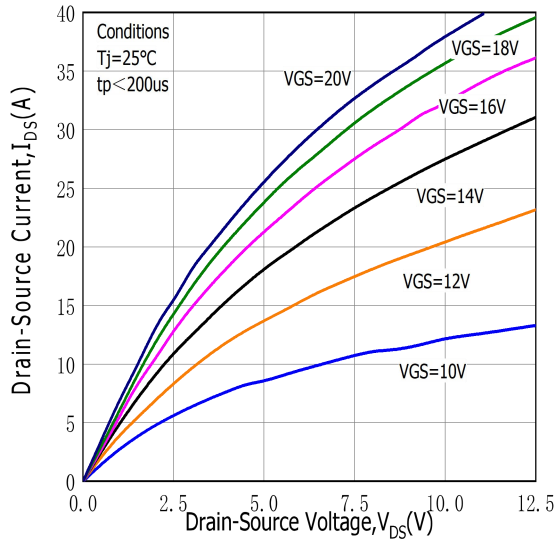

Figure.2 Output Characteristics $T_j=150^\circ\text{C}$

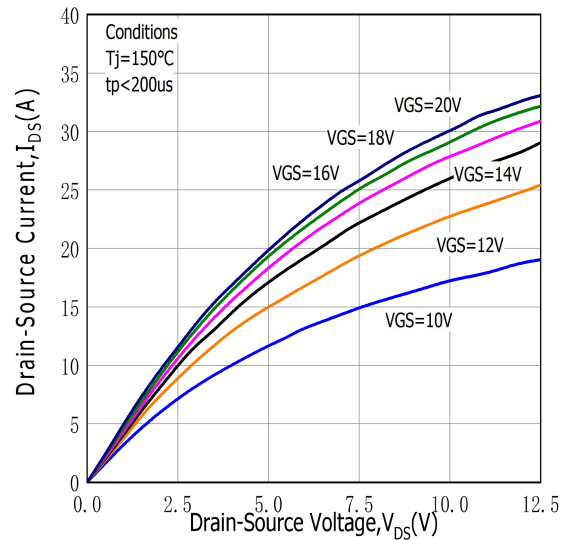

Figure.3 On-Resistance vs. Temperature

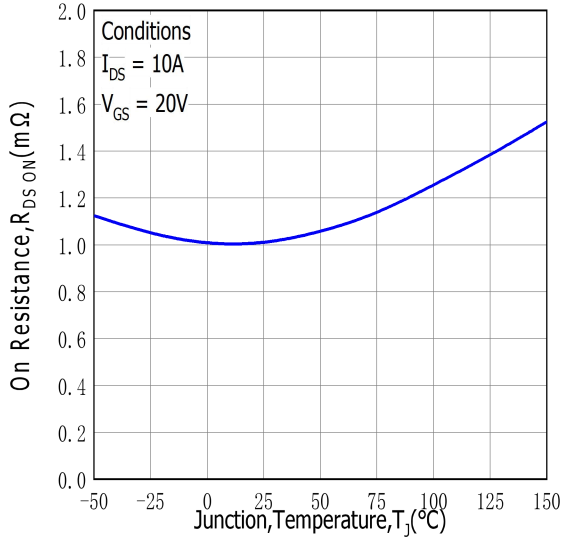

Figure.4 On-Resistance vs. Drain Current for Various Temperatures

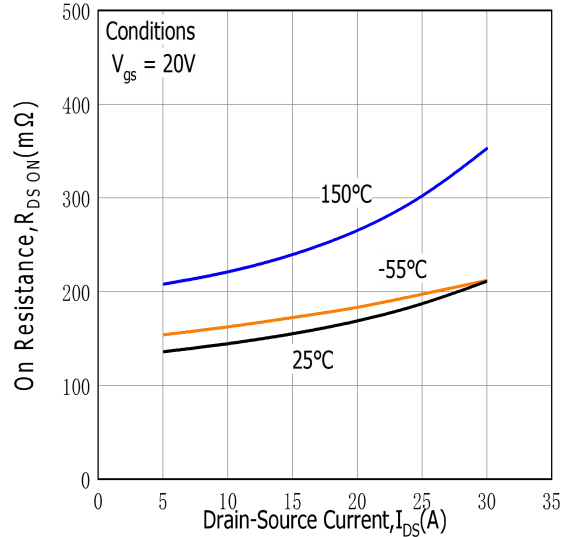

Figure.5 On-Resistance vs. Temperature for Various Gate Voltage

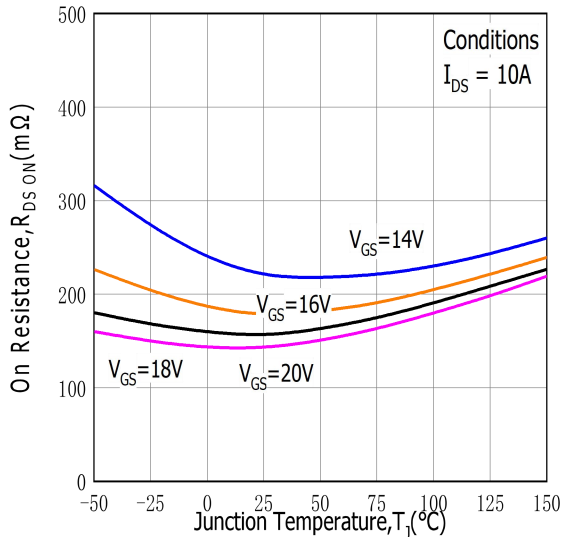

Figure.6 Transfer Characteristic for Various Junction Temperatures

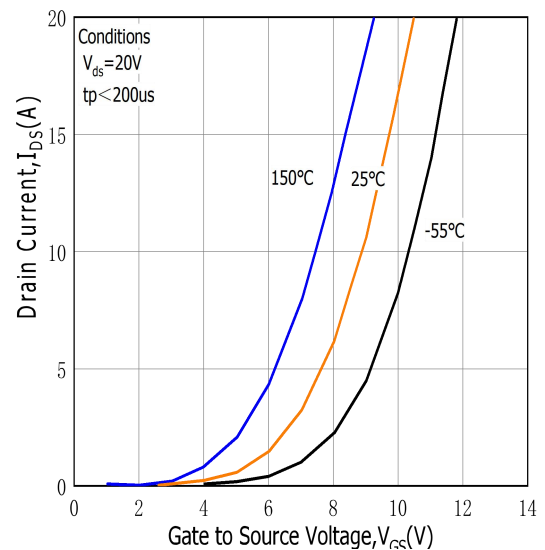

Figure.7 Body Diode Characteristic at 25°C

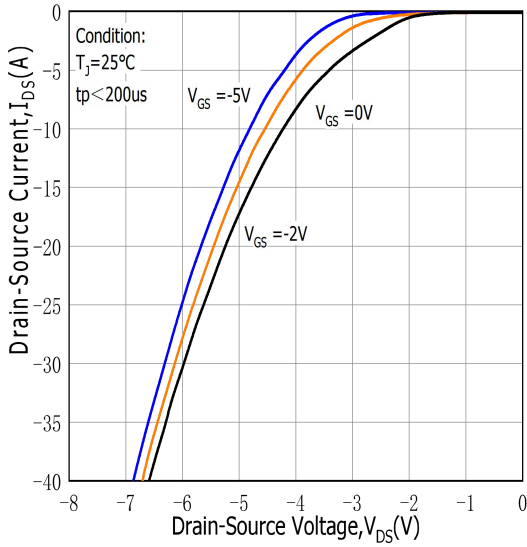

Figure.8 Body Diode Characteristic at 150°C

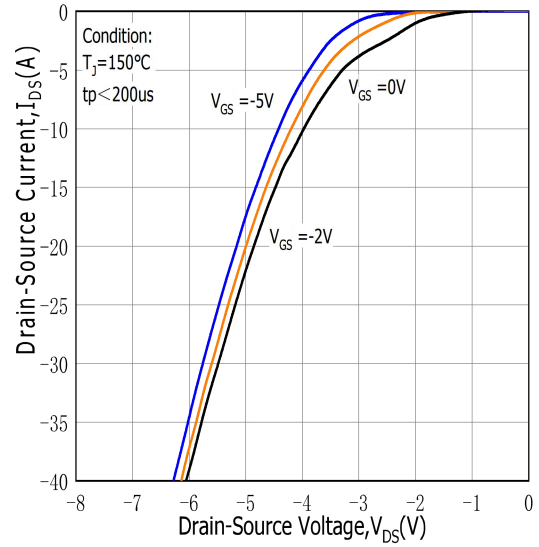

Figure.9 Threshold Voltage vs. Temperature

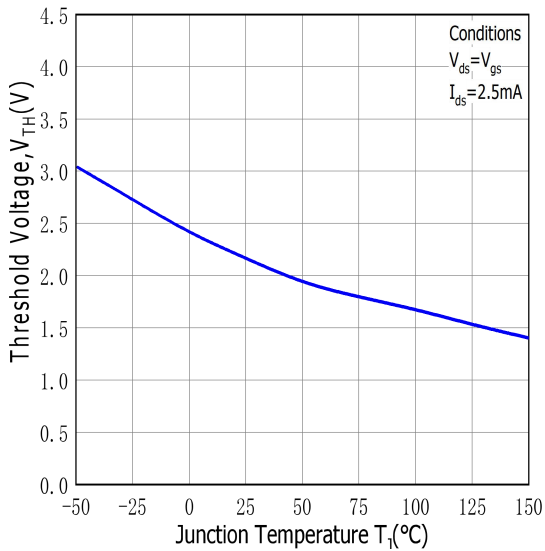

Figure.10 Capacitances vs. Drain-Source Voltage(0-200V)

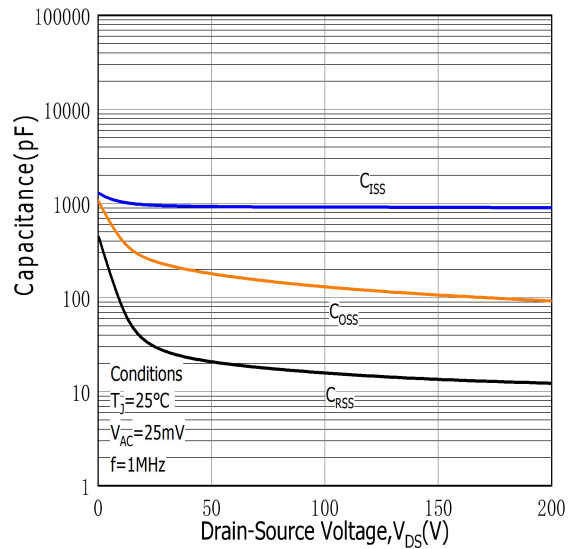
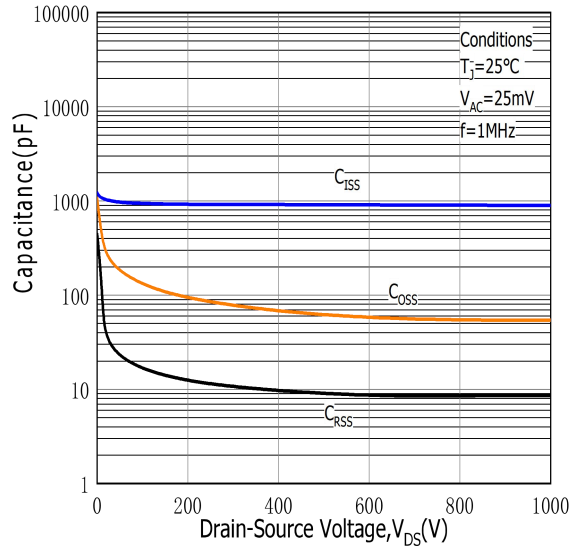
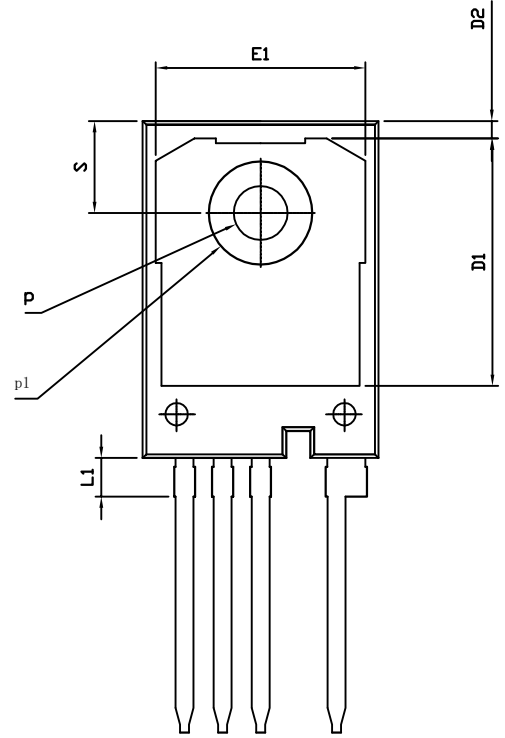
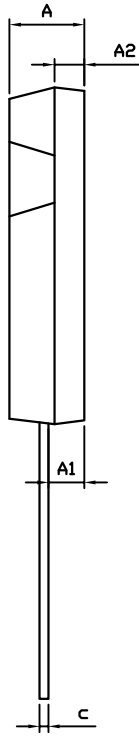
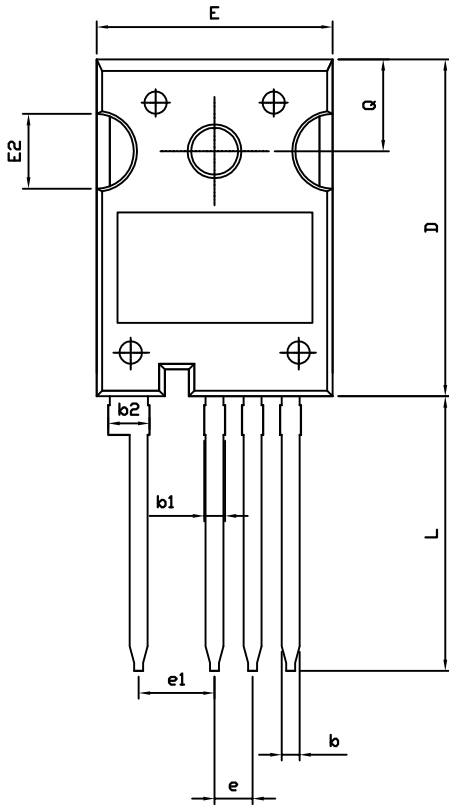

Figure.11 Capacitances vs. Drain-Source Voltage(0-1000V)



TO-247-4L PACKAGE OUTLINE



RECOMMENDED LAND PATTERN

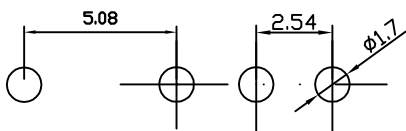

UNIT: mm

	MIN	NOM	MAX
A	4.80	5.00	5.20
A1	2.25	2.40	2.45
A2	1.85	2.00	2.15
b	1.05	1.20	1.35
b1	1.00	1.30	1.60
b2	2.35	2.65	2.95
c	0.50	0.60	0.70
D	22.34	22.54	22.74
D1	16.00	16.50	17.00
D2	0.97	1.17	1.37
e	2.34	2.54	2.74
e1	4.88	5.08	5.28
E	15.60	15.80	16.00
E1	13.50	14.00	14.50
E2	4.80	5.00	5.20
L	18.08	18.38	18.68
L1	2.38	2.58	2.78
p	3.50	3.60	3.70
p1	6.60	6.80	7.00
Q	6.00	6.15	6.30
S	6.00	6.15	6.30